

4315

1500 ml Packo



Product part	Product code	Materials
Packo container	4315	HDPE

Capacity	ML	US Fluid ounces
Brimful	1575	53.26
When closed	1500	50.72

Hazardous material information	
Hazardous material type	Solids
Packaging group	I – II – III
UN marking	1H2/X2.0/S/--/B/CURTEC-080062
Maximum gross mass (kg)	X=2.0 Y=3.0 Z=4.5

Weight	Grams	Ounces
Packo container	101.0	3.56

Weight tolerance
All products have a tolerance of $\pm 4\%$ of the initial weight mentioned on this data sheet

Dimensional tolerance (mm) according to DIN16742-TG7

Over	1	>3	>6	>10	>18	>30	>50	>80	>120	>180	>250	>315	>400	>500	>630	>800
up to	3	6	10	18	30	50	80	120	180	250	315	400	500	630	800	1000
NW (\pm)	0.20	0.29	0.35	0.42	0.50	0.60	0.90	1.25	1.45	1.60	1.80	2.60	3.50	4.00	4.50	5.00

Standard color(s)	Color code	PMS references
Packo container*	White 004	/

* Other colors available on request

Product identification

Manufacturer ID	Bottom
Product code	Bottom
Recycle logo / Material type	Bottom
Date clock	Bottom
UN-mark	Bottom
Food logo	Bottom
Material track clock	Bottom
CFR49-mark	--

Other information
 The container can be opened and closed with just a quarter-turn
 All compatible lids are equipped with integrated tear-off tamper evident seal
 Maximum filling temperature is 70°C/ 158°F
 Contents must have cooled to 30°C/ 86°F before containers can be closed and stacked
 DoC available on request
 UN certificate available on request
 MVTR declaration available on request
 User manual available on request

DISCLAIMER

CurTec manufactures packaging material for a wide range of purposes. This declaration is restricted to the packaging material as it leaves the production facility. CurTec has neither control over final end use of the product nor over processing conditions. It is therefore the responsibility of the end user to check compliance with the relevant regulations and to validate material performance in the end application through proper end use testing.

© 2021 Property of CurTec International B.V. All rights explicitly reserved, it is not allowed to copy or communicate to other parties without written consent of CurTec.

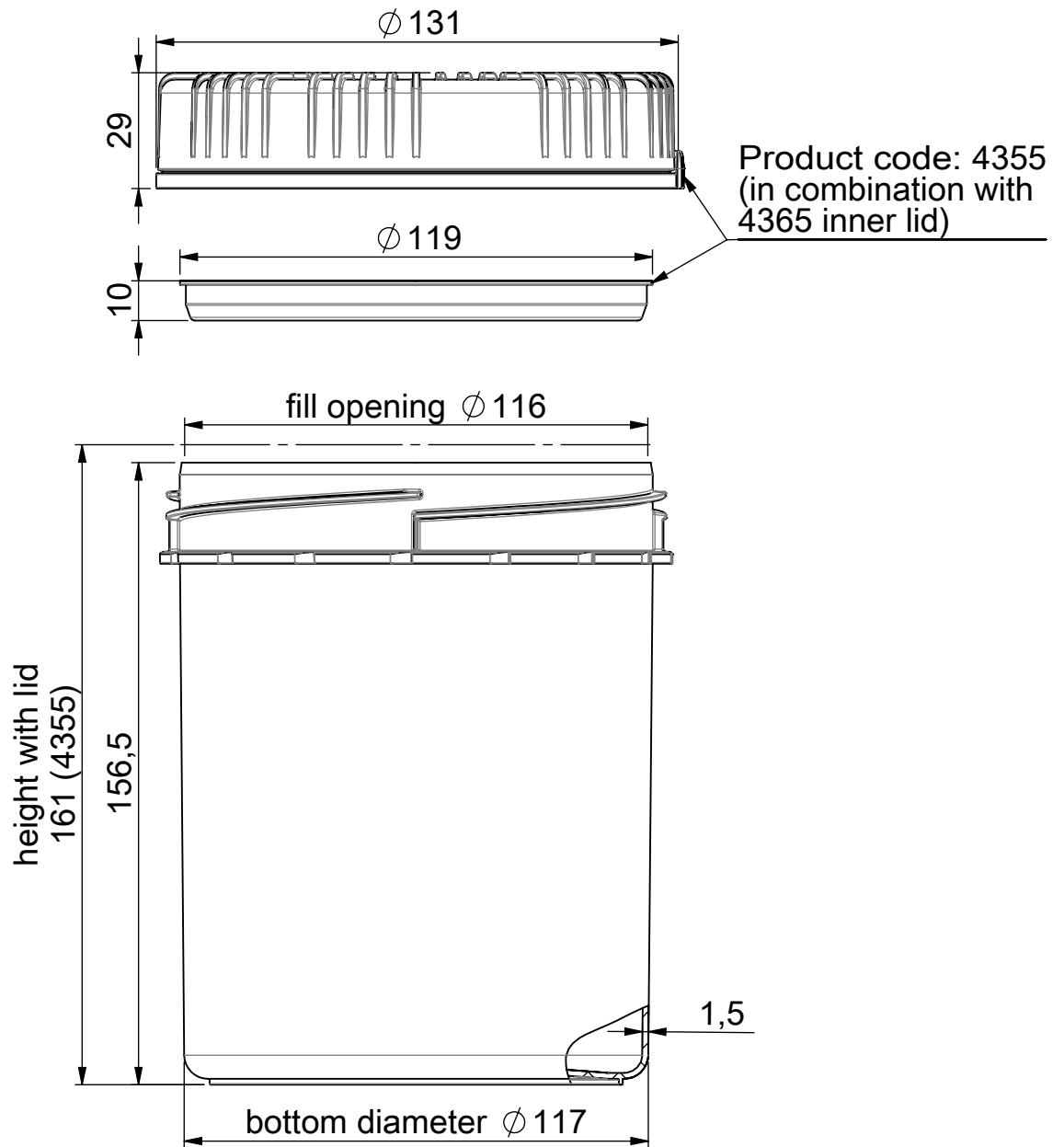

Title 4315 Packo 1500 ml

Revision	Rev. Date	Units
B	17-02-2021	mm



This document is property of CurTec Nederland B.V.
and may not be copied or communicated without written consent.
All Rights Reserved

